

Data Sheet

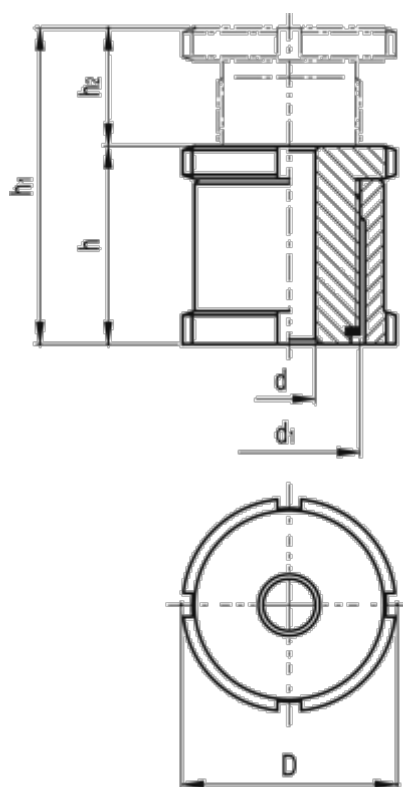

Article number: 20662235C
Description: E+G Levelling set
GN 350-58-26-A-NI

Measures



C-spanner DIN 1810 = A58-62
 d = 26.0
 D = 58
 d_1 = M40x1
For screw = M24
 h = 54
 h_1 = 86
 h_2 = 32

Max static load (N) = 148.0
Static preload (N) = 20.3
Weight (g) = 668